

Introduction to the
JBoss Application Server

Dimitris Andreadis

JBoss AS, Project Lead
JBoss, a division of Red Hat

**3rd Free / Libre / Open Source
Software Conference**

March 27-28th, 2008, Athens

About Me

- Based in Athens/Greece
 - TEI of Athens, Informatics (1993)
 - MSc. by Research, Computer Science, University College Dublin, Ireland (1995)
- 7 years in the Telco industry
 - NMS/OSS, Provisioning, Mediation, 2G/3G (Intracom Greece/Motorola Ireland)
- Involved with JBoss as a
 - User (since 2001), Contributor (2003), full-time Employee since (2004)
- Primary involvement
 - Project Lead of the JBoss Application Server (since 2006)
 - Core Developer & Maintainer of the 3.x/4.x MicroKernel
 - Worked extensively on JMX, CORBA, J2EE/JavaEE Certification
 - Member of JSR-284 expert group (Java 7-Resource Management)

Magic Quadrant for Enterprise Application Servers (Source: Gartner April 2008)

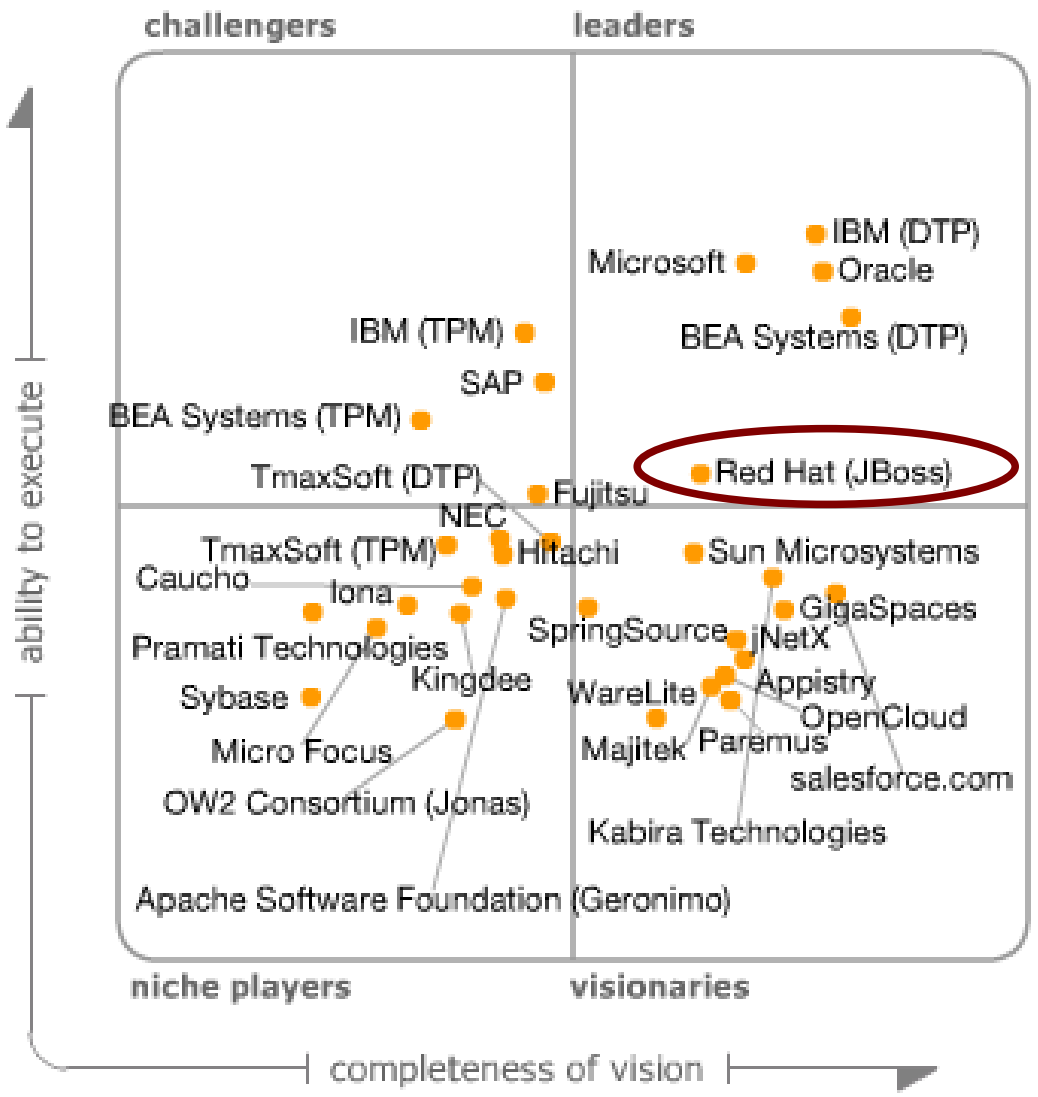



Agenda

- What is JBoss
- Who uses JBoss
- The JBoss.org Community
- JBoss.com & Red Hat
- Epilogue

What is JBoss?

What is JBoss?

- An Open Source J2EE* Server
- Founded by Marc Fleury in 1999
- Backed by a community of developers
- Yet Another Java AppServer (out of 40+)

*Java 2 Enterprise Edition

Application Servers - The Modern Mainframes

- Provide a runtime for mission-critical applications
- Solve the **Many** (clients) to **Few** (resources) problem
- User code doesn't have to deal with
 - Security
 - Transactions
 - Threading
 - Pooling
 - Caching
 - Connectors
 - Messaging
 - Clustering
 - ...



Java Enterprise Edition (EE) Standards

- Web Server (HTTP /HTTPS)
- Web Container (Servlet, JSP, JSF, etc.)
- Enterprise Java Beans (EJBs)
- Java Persistence API (JPA)
- Java Connector Architecture (JCA, JDBC)
- Java Transaction API (JTA)
- RMI-IIOP / Java IDL
- JAF / JavaMail
- Java Naming & Directory Service (JNDI)
- XML Processing (JAXP, StAX, etc.)
- Security (JASS / JACC, ...)
- Web Services (JAX-WS, JAX-RPC, JAXB, SAAJ, JAXR, ...)
- Management (JMX)
- Java Messaging Service (JMS)
- and more...

What made JBoss special?

- Open Source
 - Commercial Servers at \$10k - \$100k+
- LGPL licensed
 - Freely Use/Distribute/Embed
 - Change JBoss => contribute changes back
- Developer friendly
 - Easy installation : unzip and run!
 - Hot deployment, no pre-compilation steps, etc.
- Innovative design
 - Lightweight, modular, dynamic

Architectural Innovations

- The JBoss MicroKernel
 - A lightweight component framework that wires together a set of Services.
 - Configure the server dynamically with any set of Services and/or add your extensions.

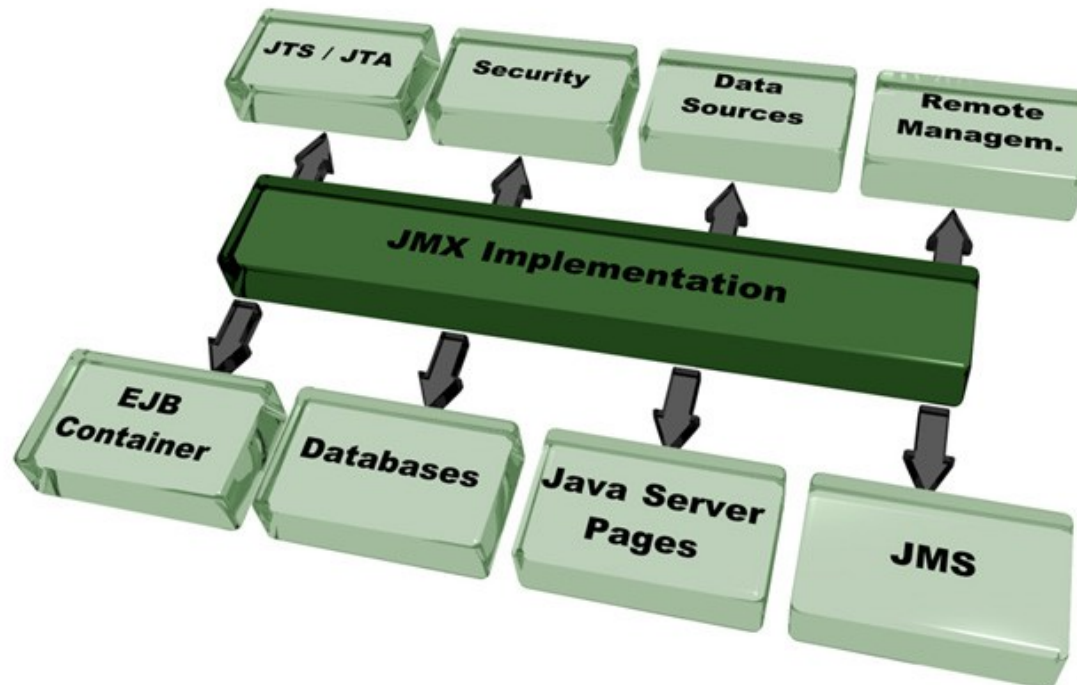

Architectural Innovations

- Aspect Oriented Design (since 2001!)
 - Introduce enterprise characteristics (e.g. Security) dynamically by changing configuration

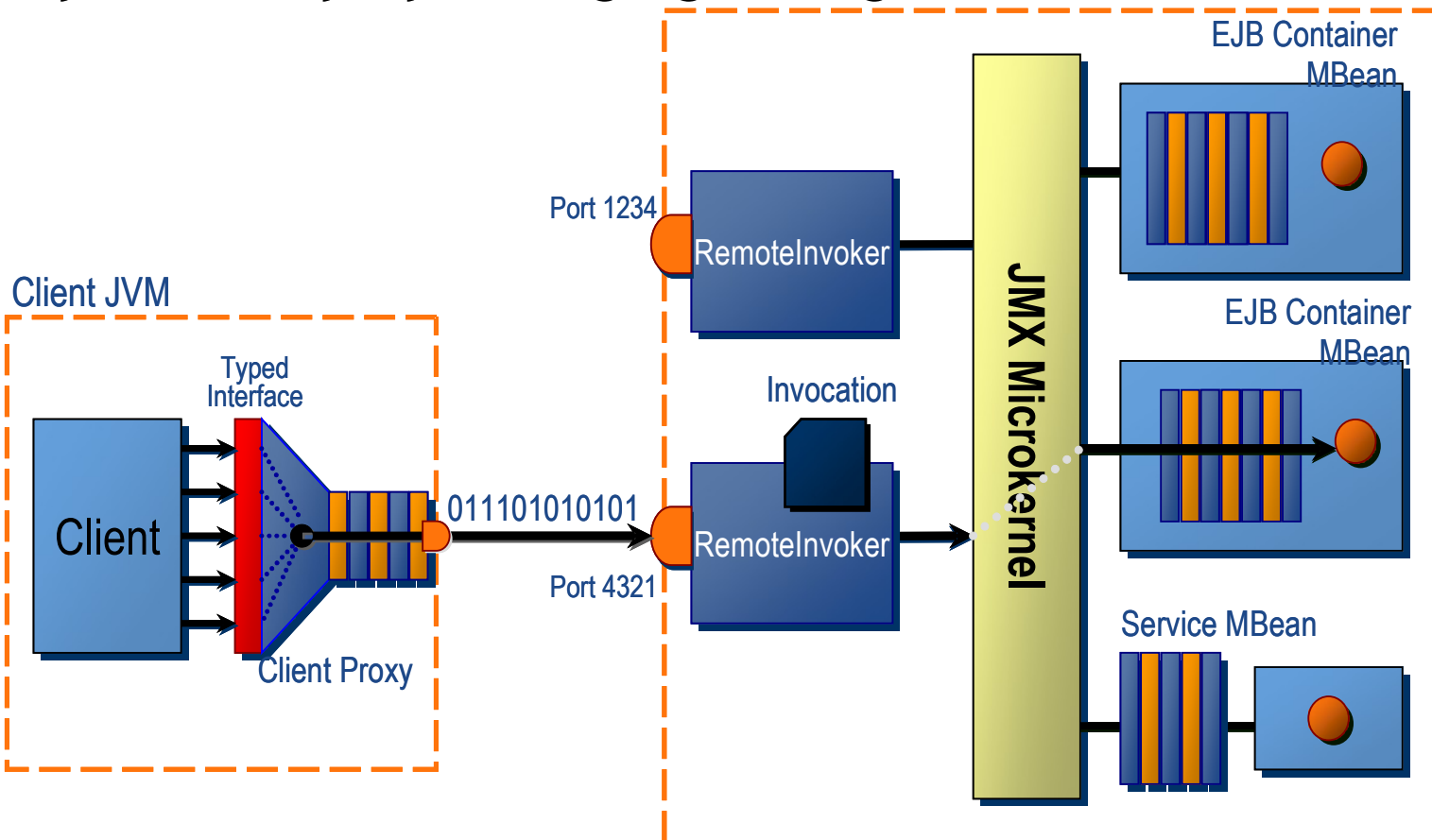

Architectural Innovations

- Out-of-the-box Clustering

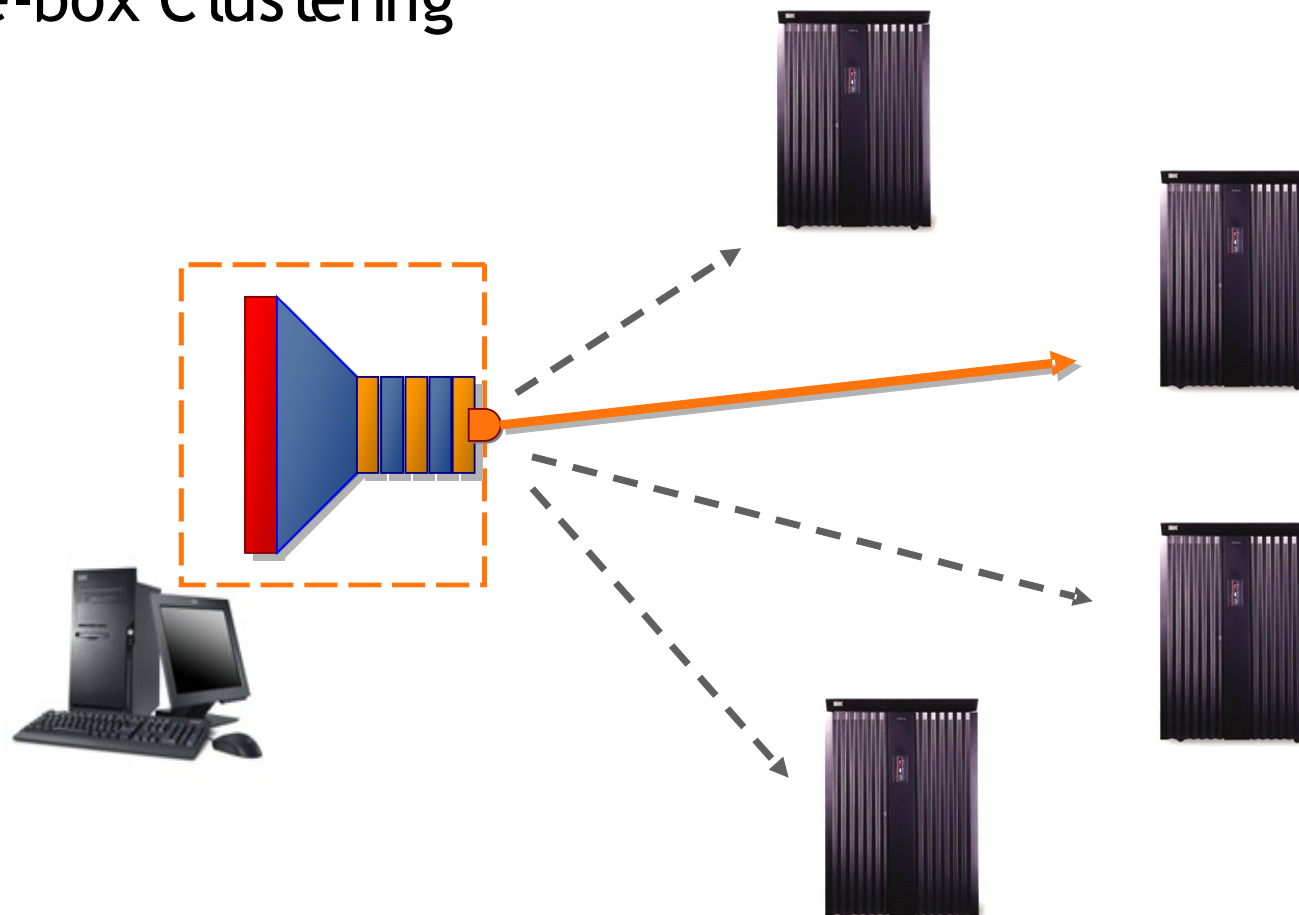



JBoss Versions

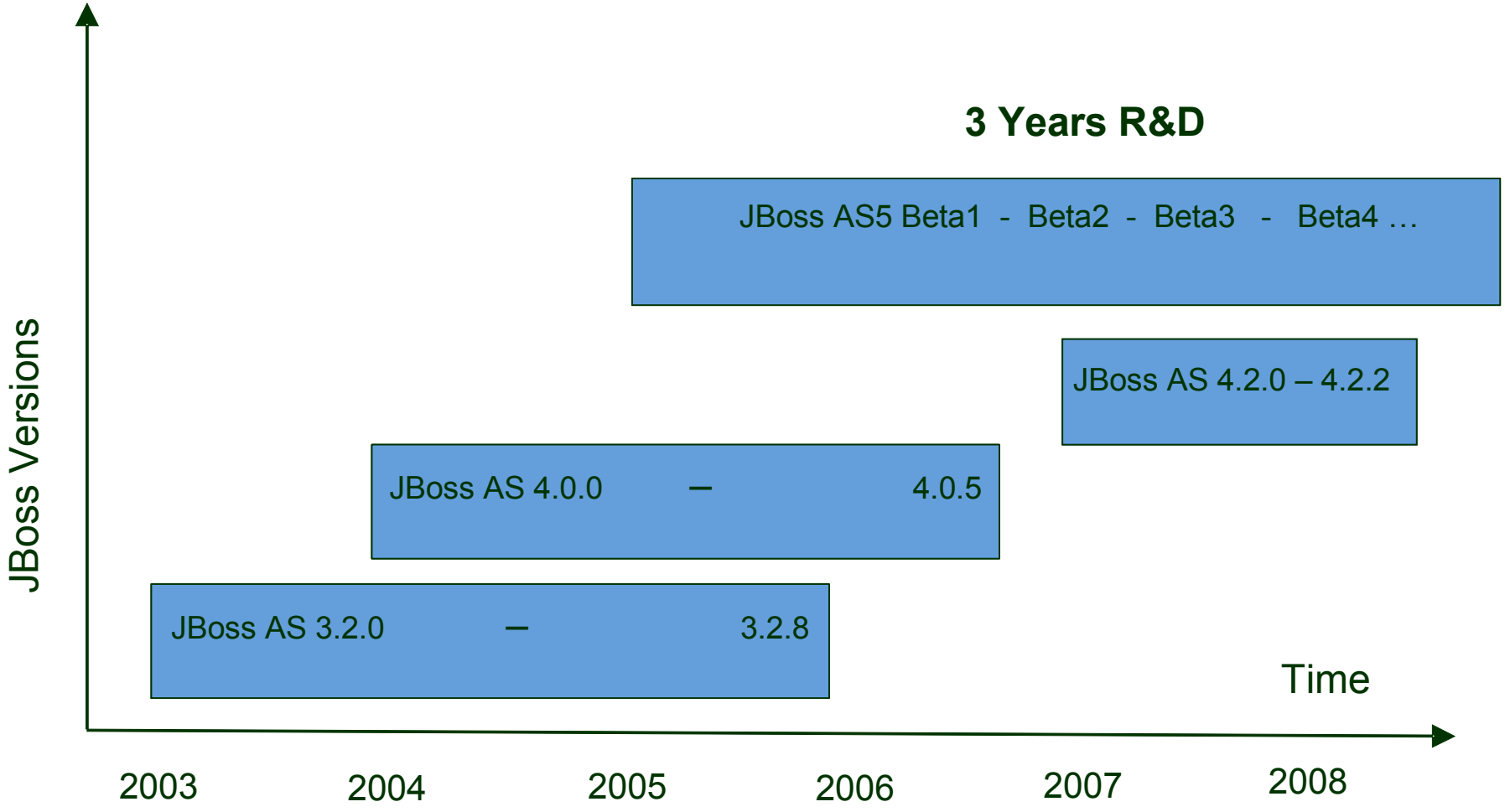



JBoss 5 Vision

- Create the most advanced server runtime architecture
 - Next Generation POJO-based Kernel (Microcontainer)
 - Support for other component models
 - Legacy JMX MBean Services
 - OSGi bundles
 - ...
- Embed any set of JBoss or Thirdparty enterprise services in arbitrary combinations and runtime environments.

Who uses JBoss?

JBoss Today

- Most used application server in Development
- 20+ Million Downloads
 - Remember, this is a development platform, not Firefox!
- Large jboss.org community
 - 250,000+ Users
 - 500+ Contributors, over time, ~30 at any time
 - 300,000+ Forum posts
 - x10 bigger community than any Open Source server

JavaPolis Dec/2007 WhiteBoard Results

Which Application Server
Do You Use?

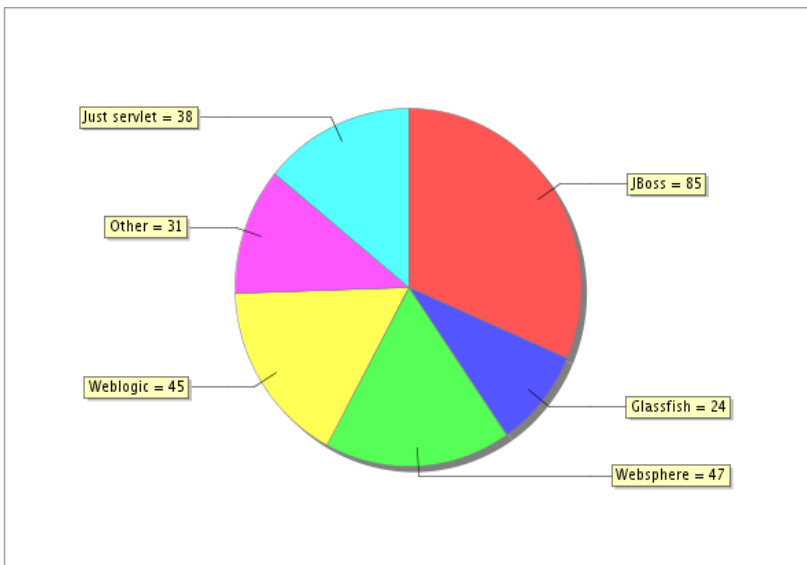

JBoss	31.5%
• Websphere (IBM)	17.4%
• Weblogic (BEA)	16.7%
• None (just tomcat)	14%
• Other	11.5%
• Glassfish (Sun)	8.9%
	<hr/>
	100%

Who is using JBoss?

(tip of iceberg)

Financial	Travel	Gov	Telecom	Media/ Entertainment	Insurance

JBoss.org



JBoss.org: 30+ Community Projects

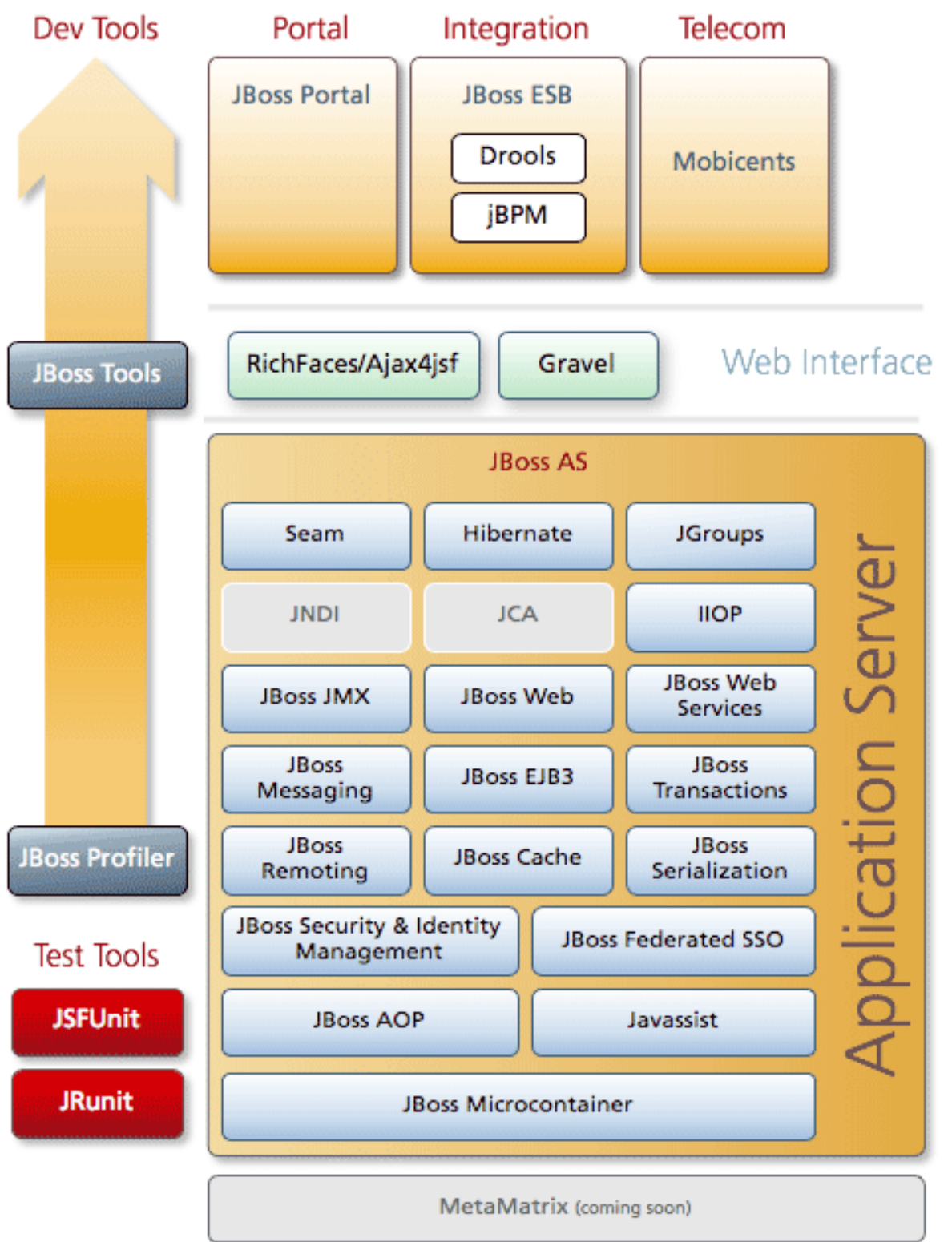



JBoss.org

- Provides the infrastructure for the community projects
 - CVS / SVN repositories
 - Continuous Builds (Hudson / CruiseControl)
 - Bug Tracking / Task Mgmt (JIRA)
 - Mailing Lists
 - Forums / Wikis
 - Website / Blogs
 - Documentation



JBoss.org - Rock Star Programmers

- Adrian Brock (UK)
- Ales Justin (Slovenia)
- Alexey Loubyansky (Ukraine)
- Bela Ban (Switzerland)
- Bill Burke (USA)
- Brian Stansberry (USA)
- Emmanuel Bernard (France)
- Francisco Reverbel (Brazil)
- Gavin King (Australia)
- Juha Lindfors (Finland)
- Juliet Viet (France)
- Kabir Khan (Norway)
- Mark Proctor (UK)
- Max Andersen (Denmark)
- Remy Maucherat (France)
- Scott Stark (USA)
- Shigeru Chiba (Japan)
- Thomas Diesler (Germany)
- Tim Fox (UK)
- ... and many more

JBoss.com

JBoss Professional Open Source

- Brand Protection
- JBoss Subscription
 - Updates, Patches, Security fixes
 - Production Support up to 24x7 with 1h response
 - Long term stability
 - Legal Assurance
- Training, Consulting, Certification
- ISV / OEM

- Most core developers are full-time JBoss employees
 - Hire elite OSS contributors from the community

Red Hat acquisition of JBoss (2006)

- JBoss formed the Middleware division of Red Hat
- An Open Source stack for the Enterprise

PROPRIETARY

BEA AQUALOGIC, IBM ESB,
BEA DATASERVICES, IBM EII

BEA/IBM PORTAL,
BEA BPM, IJOG JRULES

BEA WEBLOGIC,
IBM WEBSHERE

AIX, HP-UX, SOLARIS

EMC POWERPATH

VMWARE
VIRTUALIZATION

VERITAS
STORAGE SUITE

OPEN SOURCE

JBoss ENTERPRISE
SOA PLATFORM,
METAMATRIX

JBoss ENTERPRISE PORTAL
PLATFORM, JBoss jBPM,
RULES FRAMEWORKS

JBoss ENTERPRISE
APPLICATION PLATFORM

RED HAT
ENTERPRISE LINUX

MPIO

RED HAT INTEGRATED
VIRTUALIZATION

LVM, GLOBAL
FILE SYSTEM

Epilogue

Open Source Benefits All

- Paying Customers / Non-paying End-Users
 - Lower TCO, without sacrificing quality
 - Increase choices, invest in your people
- Software Companies
 - Viable business model for delivering software
 - Support and partnership opportunities
- Developers
 - Reuse components and reduce development time
 - Simply the best way to learn
- Technology Geeks
 - An opportunity to work and collaborate with the best minds in the industry



Join the Discussion – Get the News!

GR-JBUG – Greek JBoss User Group

<http://groups.google.com/group/gr-jbug>